

GSTF-C64 Corner Fastener (With Lock)

Features

- Available with or without spring
- With safety lock to prevent accidental release
- Suitable for applications such as doors and covers that require for dust proofing, drip proofing or anti vibration
- Can be used with padlock
- Can be used in conjunction with corner fastener hinge **GSTH-C64**

Notes

- Standard strike hook included
- Other strike hook styles **G01-613SS**, **G02-613SS**, **G07-613SS** are also available for purchase separately
- Sealing pins **G502-7SS**, **G502-9SS**, **G613-9SS** sold separately
- Clamping margin of **GSTF-C64A** shall not exceed 4 mm

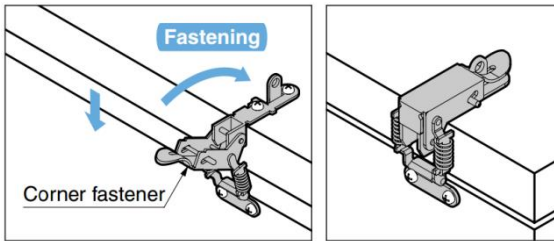

When locked



Pull lever and lift latch to open.



When opened

Clamping Margin mm	Clamping Force N	Clamping Force kgf
1	15	1.5
2	30	3.1
3	45	4.6
4	60	6.1

Clamping force is only a guide.

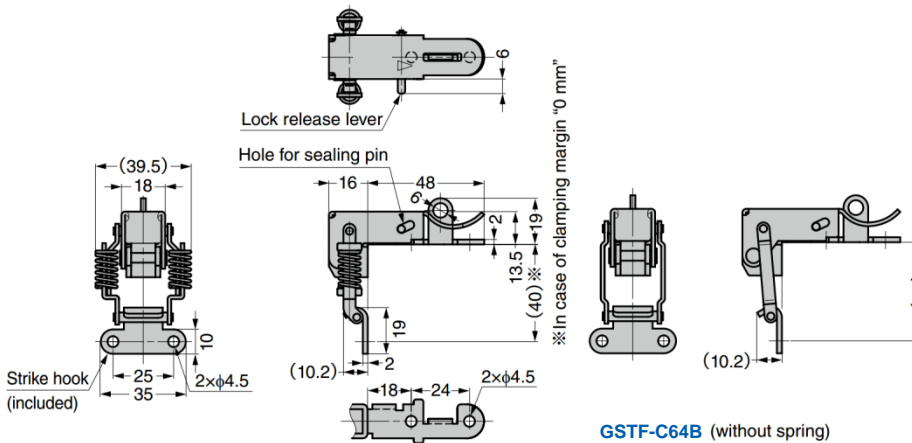

GSTF-C64A (with spring)
Gasket is unnecessary.

GSTF-C64B (without spring)
Please use with gasket. (Used in constant compression amount)

Part No.	Type	Door Thickness	Load Capacity	
GSTF-C64A	With Spring	14 ~ 28	330 N	34 kg
GSTF-C64B	Without Spring			

Sealing Pin

Features

- Used for preventing malfunction of lock release lever

Material

- Stainless steel 304, plain finish

Installation example
G502-9SS

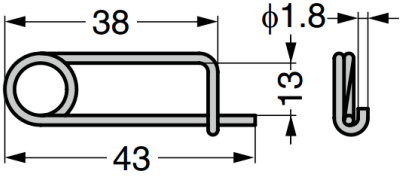
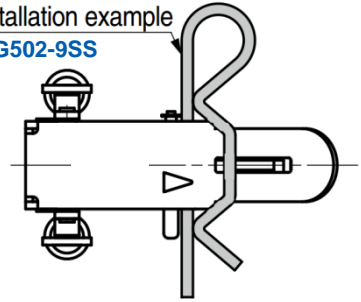

Part No.
G502-7SS

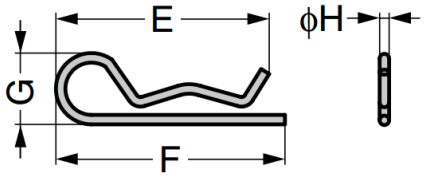

Part No.	E	F	G	H
G502-9SS	63	66	18	2.6
G613-9SS	55	59	15	2.3

Strike Hook

Material

- Stainless steel 304, barrel polished

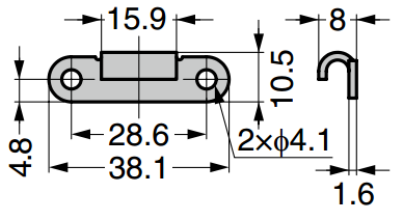

Part No.
G01-613SS

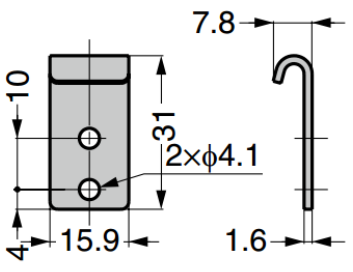

Part No.
G02-613SS

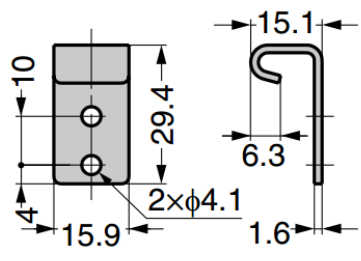

Part No.
G07-613SS